

P/N. 920-010312-00

Edition 0

JUN. 19

EZ-2P/4P

Programming Manual

The logo for GODEX, featuring the word "GODEX" in a bold, red, sans-serif font. The letters are slightly shadowed, giving it a 3D appearance. The 'O' and 'D' have a white highlight on their top-left and bottom-left curves respectively.

PROGRAMMING MANUAL 2

- 1. COMMUNICATION PORTS SPECIFICATION 2**
 - 1-1. PARALLEL INTERFACE 2
 - 2-2. SERIAL INTERFACE 2

- 2. FIRMWARE COMMANDS 3**
 - 2-1. EZPL 3
 - 2-2. LANGUAGE DESCRIPTION 5
 - 2-3. BAR CODES 14
 - 2-4. CODE PAGE 15

- 3. EXAMPLE 16**

- APPENDIX 25**
 - A. EZ-4TT/2P/4P ABOVE 2.10 25
 - B. EZ-4TT/2P/4P ABOVE 2.20 28

Programming Manual

1. Communication Ports Specification

1-1. Parallel Interface

Handshake : DSTB to printer and BUSY to host.

Interface cable : DB25 Male (IBM-PC) 36 position parallel printer cable.

Pin out : Tabulated below.

PIN NO.	FUNCTION	TRANSMITTER
1	Strobe	host
2-9	Data 0-7	host
10	Acknowledge	printer
11	Busy	printer
12	Paper empty	printer
13	Select	printer
14-16	N/C	
17	Chassis Ground	
18	N/C	
19-30	Signal Ground	
31	N/C	host
32	Fault	printer
33	Signal	ground
34-36	N/C	

2-2. Serial Interface

Serial port is set at the factory with 9600 baud-rate, no parity, 8 data bits, and 1 stop bit and uses XON/XOFF protocol as well as RTS/CTS.

The connector is RS-232 DB9 female. The pin assignments are listed below.

PIN NO.	1	2	3	4	5	6	7	8	9
NAME	+5 V	TXD	RXD	N/C	GND	DTR/CTS	N/C	DTR/CTS	N/C

PC to EZ-4TT serial port (pin to pin) description

PC Pin	EZ-4TT Pin
1	+5V
RXD 2	TXD 2
TXD 3	RXD 3
4	N/C 4
GND 5	GND 5
DSR 6	DTR/CTS 6
7	N/C 7
RTS 8	DTR/CTS 8
9	N/C 9

2. Firmware Commands

2-1. EZPL

The EZPL (EZ Programming Language) is a high - level label definition and printer control language.

The features are:

- 1) The data fields are stored and processed until the printing instruction is received.
- 2) All the data can be rotated.
- 3) Image can be downloaded and stored.

There are three basic types of commands:

- 1) Setup commands: contain the printer control instructions, configuration instructions and image download instructions. See Table 1.1
- 2) Control commands: cause the printer to take action immediately, such as cleaning memory, feeding label. See Table 1.2
- 3) Label formatting commands: defined field data, such as Line, Rectangle, Barcode, Text and Images. See Table 1.3

Setup Command	Syntax	Page
Stop position setting	^Ex	5
Printing darkness set	^Hx	5
Number of printing pages	^Px	5
Label length setting	^Q _{x,y} (,z±)	5
Speed setting	^Sx	6
Number of copy per label	^Cx	6
Row column adjustment	^Rx	6
Label format begin sign	^L	6
Stripper sensor	^Ox	6
Download label format	^Fname	6
Recall label format	^Kname	7
Label Width (EZ2P/4P only)	^W _{xx}	7
Number of label per cut	^Dx	7

Table 1.2 Control Commands		
Control Command	Syntax	Page
Clean image buffer	~Ax	7
Graphics download to external Flash card	~Ex,name,length	7
EZ-4TT graphic driver format	~G	8
Graphic down load to internal memory	~Ix,name,length	8
Print last label	~Px	8
Print version message	~V	8
Date / Time setting	~Dm,d,y,h,i,s	8
Reset printer	~Z	8
Acknowledge from RS-232	~K	9
Printer header testing	~T	9
Clear flash memory	~MDEL	9
Rotate printing	~Rx	9
Print the available space and data name in the memory card	~Xn	9

Table 1.3 Label Formatting Commands		
Label Formatting Command	Syntax	Page
Define date layout	Daa bb cc	9
Serial number setting	Cx,s,±value,prompt	10
Terminate label formatting mode and print label	E	10
Single line image data	Gwxxx	10
Line command	La,x,y,x1,y1	10
Rectangle command	Rx,y,x1,y1,lrw,ubw	10
Define time layout formatting	Th m s	10
Graphics	Yx,y,name	11
Text command	At,x,y,x_mul,y_mul,gap,rotation,data	11
Barcode command	Bt,x,y,narrow,wide,height,rotation,readable,data	11
PDF 417 command	Px,y,w,h,r,c,ec,len	12
Maxicode command	Mx,y,sno,nos,mode,ccode,zip,class,rotation,message	12
Define variable field	Vxx,length,prompt	13
Pattern command	Qx,y,width,height	13

**** 1mm = 8dots (203dpi) = 12dots (300dpi) ****

2-2. Language Description

Rules and syntax

EZPL commands have parameter strings associated with them. The commands begin with a letter as ID for each function. The comma (,) is the delimiter to separate each parameter. The **CR** [Carriage Return: decimal (13), hex (0D)] is the end of every command. Control and Setup commands use the tilde (~) and caret (^) prefix. Label Formatting command have no prefix.

Example: “ ~Ex,name,length ↵” is an image download command, (E) with three parameters (x,name,length) and end with a “CR”.

* Setup Commands

1. Stop position setting

Syntax : ^Ex
Parameters : x = 0 ~ 40 (unit : mm)
Description : Feed paper to desire stop position.
The suggestion value of x is 10 for stripper operation, 12 for label gap paper, 32 for EZ-4TC, 10 for EZ-2PC and 19 for EZ-4PC.

2. Printing darkness set

Syntax : ^Hx
Parameters : x = 00 ~ 19
Description : Set printing darkness.

3. Number of printing pages

Syntax : ^Px
Parameters : x = 1 ~ 32767
Description : This command tells the printer how many labels to print; and it will initiate the program.(refer page17)

4. Label length setting

Syntax : ^Qx,y,(z±)
Parameters :
Die cut label: ^Qx,y (see fig. 1)
x = Label length (unit : mm)
y = Gap length (1~13mm)
Plain paper: ^Qx,0,z
x = Label length (unit : mm)
y = 0 (constant)
z = Feed paper length (unit : mm)
Black line label: ^Qx,y,z± (see fig. 2)
x = label length (unit : mm)
y = black mark width (1~13mm)
z = black line to top of form position
z+ -- when the position is outside black mark. (see fig. 2)
z- -- when the position is inside black mark. (see fig. 2)
Description : Set a label size (length, gap length, [plain paper feed length])

data = the data contain the label formatting command for this stored format.

Description : Download label format into external memory card (M1 or M2). After finished the download, the printer will beep 2 times (refer page23). If do not install Flash Card (M1 or M2), the printer will beep 1 time.

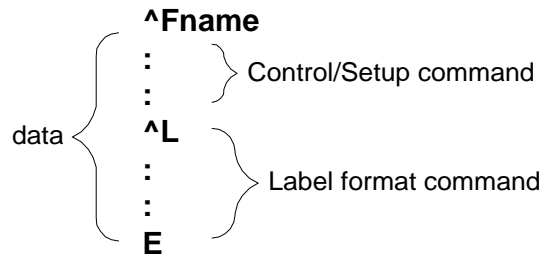

11. Recall label format

Syntax : ^Kname

Parameters : name = name of recall label format (up to 20 characters).

Description : Recall label format from external memory card (M1 or M2). (refer page23)

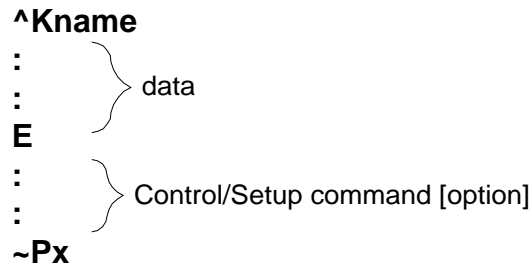

12. Label Width (EZ2P/4P only)

Syntax : ^Wxx

Parameters : x= label width

Description : Set the label width

13. Number of label per cut

Syntax : ^Dx

Parameters : X = 0 , disable cutting

X = 1 ~ 32767 , number of label per cut

Description : Number of label per cut. When you use this command, it should be matched with ^Ex.(refer page21)

* Control Commands

1. Clean image buffer

Syntax : ~Ax

Parameters : x = I ; internal image buffer.

Description : Clear the internal 64K RAM.

2. Graphics download to external Flash card

Syntax : ~Ex,name,length

Parameters : x = P, p ;PCX file

x = B, b ;BMP file
name : Name for image (up to 20 characters)
length : length of image (bytes), maximum 512K bytes
Description : Download monochrome image into external flash card. After finished the download, the printer will beep 2 times (refer page21). If do not install Flash Card (M1 or M2), the printer will beep 1 time.

3. EZ-4TT graphic driver format

Syntax : ~G
Parameters : None
Description : Printer is in the image-receiving mode. Image data are directly send from host to the printing buffer. (refer page22)

4. Graphic down load to internal memory

Syntax : ~Ix,name,length
Parameters : x = P, p ;PCX file
x = B, b ;BMP file
name = name for image (maximum character length 20 character)
length = length of image (bytes), maximum 64K bytes
Description : Download monochrome images into internal memory. After finished the download, the printer will beep 2 times (refer page21).

5. Print last label

Syntax : ~Px
Parameters : x = 1 ~ 32767
Description : This command will repeatedly print the indicated copies of last label format. (refer page17)

6. Print version message

Syntax : ~V
Parameters : None
Description : print firmware version (refer page23)

7. Date / Time setting

Syntax : ~Dm,d,y,h,i,s
Parameters : m = Month (01~12) h = Hour (00~23)
d = Day (01~31) i = Minutes (00~59)
y = Year (Last two digits of year) s = Seconds (00~59)
Description : setting Real time clock(refer page18)

8. Reset printer

Syntax : ~Z
Parameters : None
Description : Reset the printer. The LED will flash once.

9. Acknowledge from RS-232

Syntax : ~Kn
Parameters : N = 0, disable
 N = 1, enable (enable the printer to send a character to PC through RS-232)
Return Value : Y8
Description : Acknowledge a Y(0D0A) from RS-232 back to host each printing label

10. Printer header testing

Syntax : ~T
Parameters : None
Description : This command will print a pattern for the user to determine if the print head is damaged (refer page23)

11. Clear flash memory

Syntax : ~MDEL
Parameters : None
Description : Clear all of the information in the external flash memory. When you use external memory the first time, send this command to clear the external memory.

12. Rotate printing

Syntax : ~Rx
Parameters : x = label width ; from 1 to 104 (unit : mm)
Description : Rotate the label formats a 180-degree when printing. (refer page23)
Return the original print direction, setting x > 104.

13. Print the available space and data name in the memory card

Syntax : ~Xn
Parameters : n = 1, print label format name and available space in memory card.
 n = 2, print graphics name and available space in memory card.
 n = 3, print fonts name and available space in memory card.
 n = 4, print the name of the label format, graphics and fonts, and available space in memory card.
Description : Print the available space in the memory card (unit: bytes)

Label Formatting Commands

1. Define date layout

Syntax : Daa|bb|cc
Parameters : aa, bb and cc define the year, month and day, the available formats are as following.
 y2 : year with two digits (97)
 y4 : year with four digits (1997)
 me : Month in letters (JAN, FEB,)
 mn : Month in numeric (01, 02,)
 dd : Day in numeric
 | : separator, it can be any ASCII character between decimal 32 to 63.
Description : define the date layout for print out(refer page18)

2. Serial number setting

Syntax : Cx,s,±value,prompt
Parameters : x: 0~9
 s: start value of serial variable (up to 13-digit)
 ±value: inc. / dec. value of serial variable (up to 12-digit)
 prompt: prompt of serial variable (up to 20 characters)
Description : Set the serial number(refer page17)

3. Terminate label formatting mode and print label

Syntax : E
Parameters : None
Description : Ending formatting command; printer will print label after receiving this command.

4. Single line image data (sub-command of ~G)

Syntax : Gwxxx
Parameters : wxxx...
 w : byte number of image data (xxx...)
Description : This command is sub-command of ~G. It is sent by binary data. W is the digits number byte of image data. (refer page22)
Example. If the image size is 50 bytes, the command is G2xxx ... (2 : ASCII is 50 decimal [32H, 50 sec])

5. Line command

Syntax : La,x,y,x1,y1
Parameters : a = o, overwrite line
 a = e, exclusive OR line
 x : left-up
 per horizontal (Hori.) pos. (dots; 1mm = 8 dots)
 y : left-upper vertical (Vert.) pos. (dots)
 x1: right-bottom Hori. pos. (dots)
 y1: right-bottom Vert. pos. (dots)
Description : Define a line to render in the label. (refer page19)
 ** the diagonal line draw is not available **

6. Rectangle command

Syntax : Rx,y,x1,y1,lrw,ubw
Parameters : x : left-upper Hori. pos. (dots)
 y : left-upper Vert. pos. (dots)
 x1 : right-bottom Hori. pos. (dots)
 y1 : right-bottom Vert. pos. (dots)
 lrw : thickness of left, right border (dots)
 ubw : thickness if upper, bottom border (dots)
Description : Draw a rectangle in the label (refer page19)

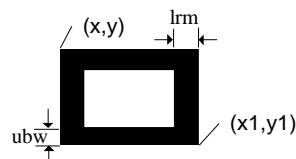

7. Define time layout formatting

Syntax : Th|m|s
Parameters : h = hour format (2 digits from 0 ~ 23)
 m = minutes (2 digits from 00 ~ 59)

s = seconds (2 digits for 00 ~ 59)
 | = separator (It can be any separator between dec. 32 to dec. 63)

Description : Define the time layout for internal real-time clock. (refer page18)

8. Graphics

Syntax : Yx,y,name

Parameters : x : Hori. pos. of left-upper of graphics (dots)
 y : Vert. pos. of left-upper of graphics (dots)
 name : Name of graphics download

Description : Put the download graphic into label at the chosen position. (refer page21)

**Example : A graphic in printer name
 “ Graphic1 ”**

command **Y20,40,Graphic1** will put this graphic into label at position (20,40)

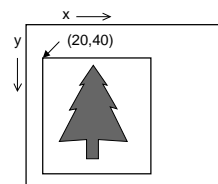

9. Text command

Syntax : At,x,y,x_mul,y_mul,gap,rotation,data

Parameters : t : Font type (203dpi) - A~H for code page 850, I for ASCII

t: Font type (300dpi) – A ~ I for code page 850, J for ASCII

203dpi			300dpi		
Font	Points	Font style	Font	Points	Font style
A	6	CG Triumvirate	A	4	CG Triumvirate
B	8	CG Triumvirate	B	5.3	CG Triumvirate
C	10	CG Triumvirate	C	6.7	CG Triumvirate
D	12	CG Triumvirate	D	8	CG Triumvirate
E	14	CG Triumvirate	E	9.3	CG Triumvirate
F	18	CG Triumvirate	F	12	CG Triumvirate
G	24	CG Triumvirate	G	16	CG Triumvirate
H	30	CG Triumvirate	H	20	CG Triumvirate
I	16x26 dots for US ASCII 8 bit		I	I	CG Triumvirate
			J	10.7*17.3 dots for ASCII	
Z	Chinese (Simplified, Traditional), Korean etc (only font card use).				

x : Hori of left-bottom position of text (unit : dot, 1 mm = 8 dots)

y : Vert. of left-bottom position of text (unit : dot, 1 mm = 8 dots)

x_mul : Hori. expansion (1-10)

y_mul : Vert. expansion (1-10)

gap : Distance of the character (unit : dot, 1 mm = 8 dots)

rotation : Rotation of text (0-3)

0) 0° 1) 90° 2) 180° 3) 270°

data : Data string (up to 239 characters)

1. constant

2. date information. (^D)

3. time information. (^T)

4. serial variable data. (^Cx)

5. variable data . (^Vxx)

10. Barcode command

Syntax : Bt,x,y,narrow,wide,height,rotation,readable,data

Parameters : t : bar-code type

A	CODE 39	L	UPC E - Add ON 2
B	EAN 8	M	UPC E - Add ON 5
C	EAN 8 - Add ON 2	N	I 2 of 5
D	EAN 8 - Add ON 5	O	CODABAR
E	EAN 13	P	Code 93
F	EAN 13 - Add ON 2	Q	Code 128 (subset a,b,c)
G	EAN 13 - Add ON 5	R	UCC 128
H	UPC A	S	Post NET
I	UPC A - Add ON 2	T	DUN 14 ONLY 90
J	UPC A - Add ON 5	U	EAN 128
K	UPC E	V	RPS 128

x : Hori. of left-bottom pos. of bar-code (unit : dot, 1 mm = 8 dots)

y : Vert. of left-bottom pos. of bar-code (unit : dot , 1 mm = 8 dots)

narrow (x dimension): narrow bar from 1~10 dots (0.125 ~ 1.25 mm)

** DUN 14 narrow setting from 5~8 dots **

** UPC & EAN narrow setting from 2 ~ 4 dots **

wide : wide bar from 2~30 dots (0.25 ~ 0.5 mm)

** CODE 39, 93, CODABAR & I 2 of 5 only **

height : height of bar-code from 24 ~ 1200 dots.

rotation : rotation of bar-code (0 -3)

0) 0° 1) 90° 2) 180° 3) 270°

readable : 0 - label off , 1 - label on

data : bar-code data

1. constant
2. date information. (^D)
3. time information. (^T)
4. serial variable data. (^Cx)
5. variable data . (^Vxx)

11. PDF 417 command

Syntax : Px,y,w,h,r,c,ec,len

Data

Parameters : x : Hori. of left-bottom pos. of bar-code (unit : dots).

y : Vert. of left-bottom pos. of bar-code (unit : dots).

w : width (x dimension) of the narrowest element (bar or space) in the bar code.

h : height (y dimension) of each bar code row in the symbol.

r : number of bar code rows, from 3 to 90.

c : number of bar code columns, from 1 to 30.

ec : error correction level; 0 ~ 8.

len : number of encoded data bytes, including carriage returns and line feeds.

data : data to be encoded (the length of the data is equal to len; up to 1024 characters).

12. Maxicode command

Syntax : Mx,y,sno,nos,mode,ccode,zip,class,rotation,message

Parameters : x : Hori. of left-bottom pos. of bar code (unit: dots).

y : Vert. of left-bottom pos. of bar code (unit: dots).
 sno : symbol number, in set of symbols 1 ~ 8.
 nos : number of symbols in set of symbols 1 ~ 8.
 mode : mode of maxicode 2, 3, 4 or 6.
 zip : postal code
 9 digits for US style postal code. If there is five digits zip code, four zeros must be padded.
 6 digits alphanumeric zip code for non-US style postal code.
 ccode : three digit country code.
 class : service class, 3 digit numeric.
 rotation : rotation of bar-code (0 : 0°)
 message : 1 ~ 84 characters.

13. Define variable field

Syntax : Vxx,length,prompt
 Parameters : xx = from 00 ~ 29
 length = number of characters (up to 98 characters)
 prompt = prompt of variable (max. 20 characters)
 Description : User define variable field setting(refer page23)

14. Pattern command

Syntax : Qx,y,width,height
 data...
 Parameters : x = Hori. of left-bottom pos. (unit : dots).
 y = Vert. of left-bottom pos. (unit : dots).
 width = width of graphic (unit : byte)
 height = height of graphic (unit : dots)
 (data length = width x height)

Description :

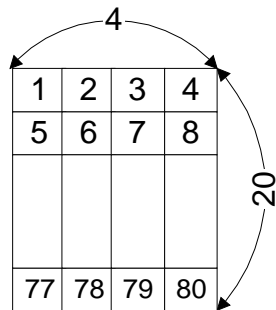



















(refer page22)

1 bit = 1 dot
 1 byte = 8 bits = 8 dots = 1 mm

data send out:
 1 2 3 477 78 79 80

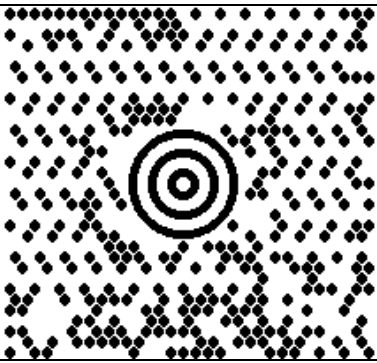
width = 4 ; height = 20
 (data length : 4x20 = 80)

2-3. Bar Codes

CODE	SAMPLE	CODE	SAMPLE
Code 39	 CODE39	UPC E Add on 2	
EAN 8		UPC E Add on 5	
EAN 8 Add on 2		I 2 of 5	
EAN 8 Add on 5		CODABAR	
EAN 13		Code 93	
EAN 13 Add on 2		Code 128	
EAN 13 Add on 5		EAN 128	
UPC A		MAXICODE	
UPC A Add on 2		PDF 417	
UPC A Add on 5		UPC E	

2-4. Code Page

Code page 850 compatible

(IBM compatible without graphics)

32	!	"	#	\$	%	&	'	()	*	+	,	-	.	/	
48	0	1	2	3	4	5	6	7	8	9	:	;	<	=	>	?
64	@	A	B	C	D	E	F	G	H	I	J	K	L	M	N	O
80	P	Q	R	S	T	U	V	W	X	Y	Z	[\]	^	_
96	`	a	b	c	d	e	f	G	h	i	j	k	l	m	n	o
112	p	q	r	s	t	u	v	w	x	y	z	{		}	~	␣
128	Ç	ü	é	â	ä	à	å	ç	ê	ë	è	ï	î	ì	Ä	Å
144	É	æ	Æ	ô	ö	ò	û	ù	ÿ	Ö	Ü	ø	£	Ø	×	f
160	á	í	ó	ú	ñ	Ñ	ª	º	¿	®	¬	½	¼	¡	«	»
176						Á	Â	À	©				¢	¥		
192						ã	Ã									¤
208	ð	Ð	ê	Ë	È	ı	í	î	ï					ı	ì	
224	ó	β	ô	ò	õ	Õ	μ	þ	Ɔ	Ú	Û	Ù	ý	Ý	ˉ	´
240	-	±	=	¾	¶	§	÷	¸	°	¨	.	1	3	2		€

3. Example

How to construct a label using EZ-4TT command

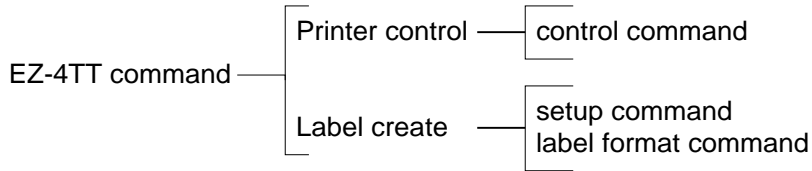

To create a label, it must be an order command combination.

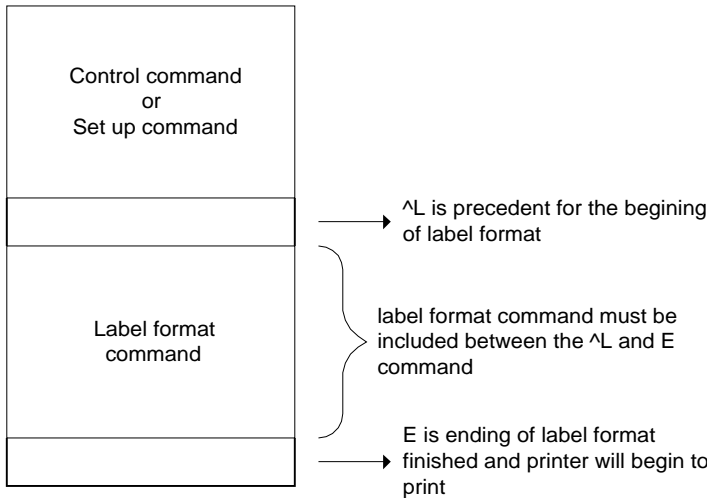

** Control or setup commands to be used in the label command area will be ineffective.

Example:

Saving the following contents (command file named: EX1).

```
^Q45,0,0
^W50
^S2
^H5
^E12
^L
AC,10,10,1,1,1,0,LABEL SAMPLE
AC,30,10,1,1,1,0,SPEED: 2
AC,50,10,1,1,1,0,DARKNESS: 5
AC,70,10,1,1,1,0,STOP POSITION: 12mm
E
```

The label can be created by the following MS-DOS command.

```
C:\>COPY EX1 PRN␣
```

1. Text printing

(1) Text/ Date/ Time printing

Example	Result
^Q50,0,2 ^W50 ^S2 ^H5 ^R10 ^L AC,10,10,1,1,1,0,EZ-4TT PRINTER AC,10,50,1,1,1,0,^D AC,10,100,1,1,1,0,^T E	EZ-4TT PRINTER MAY/09/97 08:39:36

- The date output is default setting and user can change it with D command (see page 9)
- The time output format is default setting and user can change it with T command (see page 10)

(2) Serial number string printing

Example 1	Result	Example 2	Result
^Q10,0,0 ^W50 ^S2 ^H5 ^P8 ^L C0,0000,+2,A1 AB,10,10,1,1,2,0,^C0 E	0000 0002 0004 0006 0008 0010 0012 0014	~P6 ; If you want to continue printing the serial number from 0016 by 6 labels, send ~P6 .	0016 0018 0020 0022 0024 0026
Example 3	Result	Example 4	Result
^Q10,0,0 ^W50 ^S2 ^H5 ^P4 ^C2 ^L C0,0000,+2,A1 AB,10,10,1,1,2,0,^C0 E	0000 0000 0002 0002 0004 0004 0006 0006	^Q10,0,0 ^W50 ^S2 ^H5 ^P8 ^L C0,0000,+2,A1 AB,10,10,1,1,2,0,abc^C0def E	abc0000def abc0002def abc0004def abc0006def abc0008def abc0010def abc0012def abc0014def

Setting the x and y value:

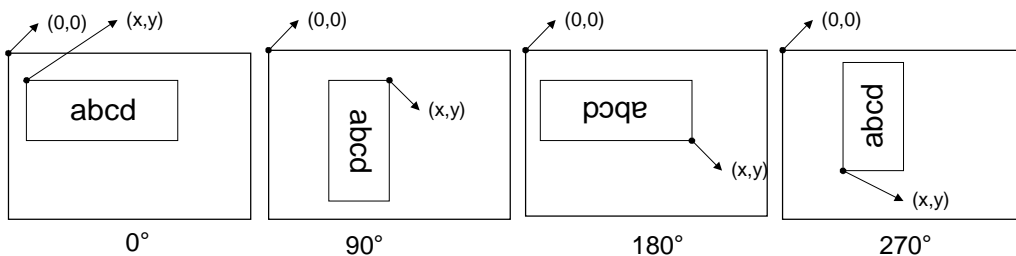

2. Adjusting the character spacing

Example	Result
^Q30,0,0 ^W50 ^S2 ^H5 ^L AC,10,10,1,1,10,0,EZ-4TT PRINTER AC,10,100,1,1,1,0,EZ-4TT PRINTER E	EZ-4TT PRINTER EZ-4TT PRINTER

3. Rotate printing

Example	Result:
^Q50,0,0 ^W50 ^S2 ^H5 ^L AC,100,30,1,1,1,0,ROTATION 0 AC,40,20,1,1,1,1,ROTATION 90 AC,260,150,1,1,1,2,ROTATION 180 AC,290,200,1,1,1,3,ROTATION 270 E	ROTATION 0 ROTATION 90 ROTATION 180 ROTATION 270

4. RTC Setting

Example	Result
~D6,16,97,9,47,00	; Date & Time setting. Send this command to printer

Example	Result
^Q20,2 ^W50 ^S2 ^H5 ^P1 ^L DY4-ME-DD ; date output format setting Th:m:s ; time output format setting AC,10,30,1,1,0,0,^D AC,10,70,1,1,0,0,^T E ; terminate label formatting mode and start to print label	1997-JUN-16 09:47:00

You can change date formatting as following formats.

Example	Result
Dy4-me-dd	1997-MAY-09
Dy4/mn/dd	1997/05/09
Dmn dd y4	05 09 1997
Dy4	1997
Dme	MAY
Ddd	09

Dy4,me	1997-MAY
Dme-dd	MAY-09

5. Barcode printing

Example	Result
^Q30,0,0 ^W50 ^H5 ^S2 ^Q30,0,2 ^L BG,20,100,3,3,100,0,1,12345678901234567 E	

6. Rotation bar-code

Example	Result
^Q40,0,0 ^W50 ^H5 ^S2 ^Q30,0,2 ^L BE,100,20,2,4,80,1,1,123456789012 E	

7. Setting bar-code serial number

Example	Result
^Q30,0,0 ^W50 ^H5 ^S2 ^Q20,0,2 ^P10 ^L C0,000,-1,A3 BE,20,100,3,3,100,0,1,111111^C0111 E	

8. Rectangle printing

Example	Description	Result
^H5 ^S2 ^Q50,2 ^W45 ^L R20,20,120,120,8,8 E	; darkness = 5 ; speed = 2 ips ; label length = 50mm, gap = 2 mm ; label width = 45mm ; (x,y) = (20,20), (x1,y1) = (120,120) lrw = 8 dots, ubw = 8 dots	

9. Line printing

Example	Description
<pre>^Q50,2 ^W52 ^H6 ^S2 ^L AB,50,60,1,1,1,1,EZ-4TT LE,10,10,60,200 BA,150,40,25,50,0,1,12345 AC,110,130,1,1,1,0,EZ-4TT PRINTER LE,100,10,400,200 E</pre>	<pre>; label length = 50mm, gap = 2 mm ; label width = 52mm ; darkness = 6 ; speed = 2 ips ; (x,y) = (10,10), (x1,y1) = (60,200) ; (x,y) = (100,10), (x1,y1) = (400,200)</pre>
Result	
	

10. PDF417 printing

Example	Result
<pre>^Q40,0,3 ^W50 ^S2 ^H5 ^L P30,20,3,3,3,3,1,100 12345678 12345678 12345678 12345678 12345678 12345678 12345678 12345678 12345678 12345678 12345678 E</pre>	

11. Maxicode printing

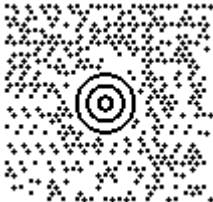
Example	Result
<pre>^Q50,0,0 ^W40 ^S2 ^H5 ^L M30,20,1,1,2,840,068107317,8,0,123456 E</pre>	

12. Stripper setting

Example	Result
^Q50,2 ^W80 ^S2 ^O1 ^E10 ^P1 ^H5 ^L AD,20,20,1,1,3,0,Stripper Function E	; label height=50mm, gap=2mm ; label width = 80mm ; speed=2 inch/sec ; stripper enable ; set stop positional is 10 mm ; printing one label ; darkness=5 ; label format begin sign

13. Cutter setting

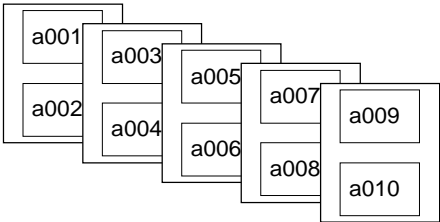
Example	Description	Result
^Q20,0,0 ^H5 ^S2 ^P10 ^D2 ^C1 ^L R10,10,120,90,2,2 C0,001,+1,A1 AC,20,30,1,1,1,0,a^C0 E	;plain paper length:20mm feed label length :0mm ;print 10 labels ;2 labels per cut	

14. Download graphic to printer's internal memory

Following the below steps to download graphic to printer.

1. Be prepared a graphic file (file name: TREE.PCX, file size: 922 bytes).
2. Be prepared two text files (TEST1.TXT and TEST2.TXT, see the following contents).

TEST1.TXT	TEST2.TXT	Print Result
~IP,TREE,922	^Q30,0,0 ^W50 ^S2 ^H5 ^L AB,50,10,1,1,1,0,INTERNAL Y30,50,TREE E	INTERNAL 

3. In DOS mode, running the following commands.

```

COPY TEST1.TXT PRN.␣
COPY TREE.PCX PRN/B.␣
COPY TEST2.TXT PRN.␣
    
```

15. Download graphic to external flash card

Refer "14. Download graphic to printer's internal memory". You just need to change the TEST1.TXT as the following contents.

TEST1.TXT
~EP,TREE,922

If your graphic file is bitmap, the command will be "~EB,TREE,922".

16. Graphic driver format

Example	Description
<pre> ^Q20,2 ^W100 ^R20 ~G G(AA G(AA G(AA G(AA G(AA G(AA G(AA G(AA G(AA G(AA G(AA G(AA G(AA G(AA G(AA G(AA G(AA G(AA G(AA E </pre>	<pre> ; left margin = 20 dots ; (: ASCII is 40 ; decimal [(= 40 bytes] ; total 14 lines, so the ; graphics height is ; 1.75mm (14 dots). </pre>
Result	
<pre> </pre>	

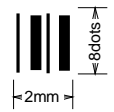

17. Pattern command setting

Example	Result
<pre> ^Q20,0,0 ^W40 ^S2 ^E23 ^H5 ^L Q20,10,2,8 GGGGGGGGGGGGGGGGGG E </pre>	<pre> </pre> <p>; length :2X8=16 ; total 16</p>
Description	
<pre> 0100011101000111 0100011101000111 0100011101000111 0100011101000111 0100011101000111 0100011101000111 0100011101000111 0100011101000111 </pre> <p>HEIGHT = 8 DOTS</p> <p>← 1 BYTE → ← 1 BYTE →</p> <p>← WIDTH = 2 BYTES →</p> <p>G : 01000111 (binary)</p>	

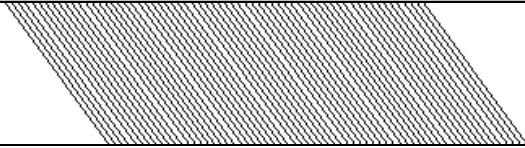
18. Print head test & Version list

Example	Result
~T	
~V	### EZ-4 TT ### ### VER. X.XX ###

19. Rotate label format at printing



Example	Description	Result
^Q30,0,0 ^S2 ^H5 ~R50 ^W40 ^L AC,20,10,1,1,1,0,ROTATE BB,20,45,2,5,50,0,1,1234567 E	; label size is 40mm(h)x50mm(w); 2mm gap ; rotate the label format 180 degree at print	
^Q30,0,0 ^S2 ^H5 ~R105 ^L AC,20,10,1,1,1,0,ROTATE BB,20,45,2,5,50,0,1,1234567 E	; disable the rotate function	

20. Download label format to external flash card & Variable field setting

Example	Description
^Ftest ^Q50,0,15 ^W70 ^H5 ^S2 ^E12 ^L C0,0000,+1,serial no. V00,10,name V01,8,barcode V02,6,price AE,108,306,1,1,1,0,\$^V02 AC,39,27,1,1,1,0,S/N.^C0 AD,126,78,1,1,1,0,^V00 BA,108,135,2,5,100,0,1,^V01 E	Define the download label format name is "test". Saving this file to TEST.CMD, at the DOS prompt mode, run the following command. TYPE TEST.CMD >> LPT1 or COPY TEST.CMD PRN ← 1 sequential number: C0 ← 3 variable field: V00, V01, V02

21. Recall label format

Example 1	Description	Result
	(Recall label format without changing the label format)	S/N.0000

^Ktest 0000 Book 12345678 200.00 E ~P1	; C0 = 0000 ; V00 = Book ; V01 = 12345678 ; V02 = 200.00	Book  * 12345678 * \$200.00
Example 2	Description	Result
^Ktest 1111 Pencil 12345678 100.00 E ^Q35,0,0 ^S3 ^H8 ~P2	(Recall label format and change label format) ; C0 = 1111 ; V00 = Pencil ; V01 = 12345678 ; V02 = 100.00 ; Change label format setting ; speed = 3"/sec ; darkness = 8 ; printing last label for twice	S/N.1111 Pencil  * 12345678 * \$100.00 S/N.1112 Pencil  * 12345678 * \$100.00

Each time you change variable data or label format, repeat to send command from ^Kname to ~Px.

Appendix

A. EZ-4TT/2P/4P above 2.10

1. Additional command

Fonts download to external memory

- Syntax : ~J?
Parameters : ? = Font type; from a ~ z or A ~ Z; up to 26 fonts
Description : Download external fonts to external flash card. If download name already exists in the flashcard, the printer will printout message "FONT NAME ALREADY EXIST" and download is not allowed. Fonts are restricted to HP Laser Jet II Plus (PCL-4) or compatible ones.
Example : Download HVR0OE1A.SFP font to external flash card.

~JA	; define A = HVR0OE1A.SFP
COPY HVR0OE1A.SFP PRN/B	; send command from DOS mode

External Text command

- Syntax : Vt,x,y,x_mul,y_mul,gap,rotation,data
Parameters : t : Font type; from a ~ z (or A ~ Z)
x : Hori of left-bottom position of text (unit : dot, 1 mm = 8 dots)
y : Vert. of left-bottom position of text (unit : dot, 1 mm = 8 dots)
x_mul : Hori. expansion (1-10)
y_mul : Vert. expansion (1-10)
gap : Distance of the character (unit : dot, 1 mm = 8 dots)
rotation : Rotation of text (0-3)
0) 0° 1) 90° 2) 180° 3) 270°
data : Data string (up to 239 characters)
1. constant
2. date information. (^D)
3. time information. (^T)
4. serial variable data. (^Cx)
5. variable data . (^Vxx)
Example : VA,5,10,1,1,1,0,data ; use font A in the label

2. Revised command

Clean image buffer

Additional function: : After the printer buffer is cleared, you would hear the beep once from the printer.

Serial number setting

- Syntax : Cx,s,±value,prompt
Parameters : x: 0~9
s: start value of serial variable (up to 13-digit)
±value: inc. / dec. value of serial variable (up to 12-digit)

prompt: prompt of serial variable (up to 20 characters)
Description : Set the serial number. An object allows at most 3 serial numbers.
Ex. AC,5,5,1,1,1,0,^C0^C1^C2

Graphics download to external flash card/ internal memory

Additional function: : If download name already exists, the printer will printout message
“ GRAPHICS NAME ALREADY EXIST” and download is not allowed.

Format download to external flash card

Additional function: If download name already exists, the printer will printout message
“ FORM NAME ALREADY EXIST” and download is not allowed.

RTC setting

The year sets from 1990 to 2089.

3. Revised function

Self Test

The self-test function helps you check if the printer works well. To get in the self-test function; please follow the steps.

1. Hold down the feed button when powering on.
2. Release the feed button after the printer beeps 4 times.
3. Wait about 3 seconds, the printer will printout contain of the self-test.

Check mode

To get in the check mode; please take the following steps.

1. Hold down the feed button when powering on.
2. Continue to hold down the feed button. The printer will beep 4 times and print out a blank label of 19cm long. When the printer stops, release the feed button.
3. The printer will print the following contents.
CHECK MODE BEGIN

Note: Disable the Check mode or Self-test, please power off the printer at least 2 seconds, than power on again.
--

Stripper operation

The first time to use strip function, the printer will send a blank label and printout very slowly. After pick up the label, the printer printout will normally.

Install the Strip Bracket Bar

The strip bracket bar was use for strip function. If you don't need to use strip function, you may take out the strip bracket bar and keep to safe place. Please follow these steps to install the strip bracket bar.

1. Refer the figure 1 to setup the strip bracket bar to the right position.
2. Refer the figure 2, follow the 3-arrow position and direction to gently insert the strip bracket bar until hear the click sound.
3. Refer the figure 2, a part of zoom out to show the strip bracket bar correct position. Please check whether the strip bracket bar was setup correct.
4. About the strip function setting, please refer the technical user's manual.

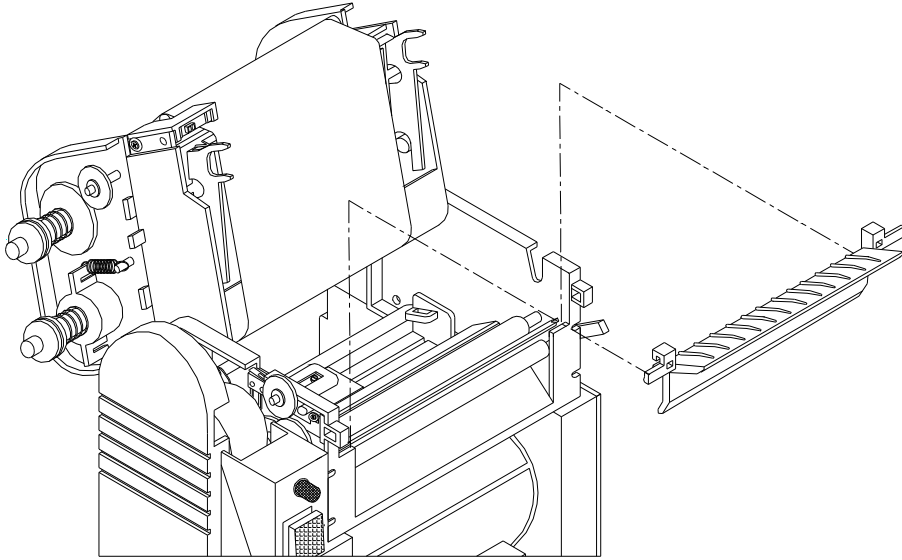

Fig. 1

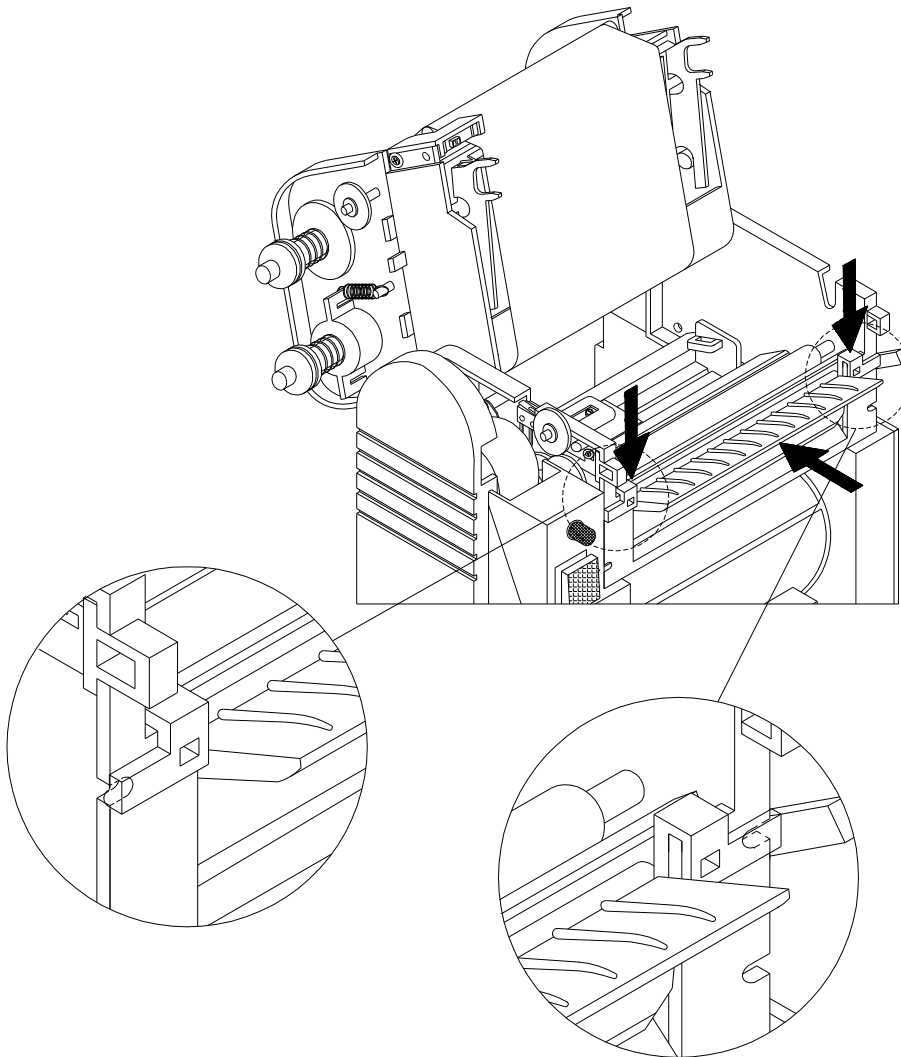

Fig. 2

B. EZ-4TT/2P/4P above 2.20

Serial number setting

Syntax : Cx,ys,±value,prompt
 Parameters : x: 0~9
 s: start value of serial variable (up to 13-digit)
 y:
 y = none, Decimal (0~9)
 y = A, Hexadecimal (0~9,A~F)
 y = C, 0~9, A~Z
 ±value: inc. / dec. value of serial variable (up to 12-digit)
 prompt: prompt of serial variable (up to 20 characters)

Description : Set the serial number. An object allows at most 3 serial numbers.
 Ex. AC,5,5,1,1,1,0,^C0^C1^C2

Example : Program (print out 5 labels): Result:
 ^Q50,0,0 000EEZY
 ^W100 001EFZY
 ^S2 002F0ZZ0
 ^H5 003F1ZZ1
 ^E12 004F2ZZ2
 ^P5
 ^L
 C0,000,+1,AA
 C1,AEE,+1,BB
 C2,CZYY,+1,CC
 AC,5,5,1,1,1,0,^C0^C1^C2
 E

Cutter setting

EZ-4TC		
SW7	ON	Rotary Cutter
	OFF	Guillotine Cutter

EZ-4PC		
SW7	ON	Guillotine Cutter
	OFF	Rotary Cutter

The maximum paper width accepts is 110 mm; and the acceptable minimum label height is 30 mm.

Guillotine Cutter Adjustment

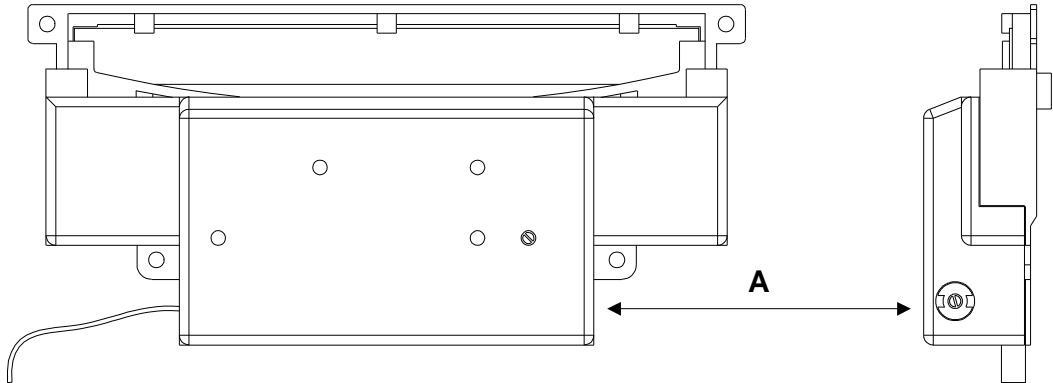

1. There is an adjustable showed as arrow “A” on the left side of cutter.
2. The paper jam may cause the cutter work improperly, please power off the printer.
3. Use \ominus type screw driver insert into the opening “A” and turn clockwise. The blade of cutter should be opened, remove the paper inside the cutter.
4. After the paper jam problem is eliminated, power on the printer, at this moment, the cutter will regress automatically to cutting position.

Rotary Cutter Adjustment

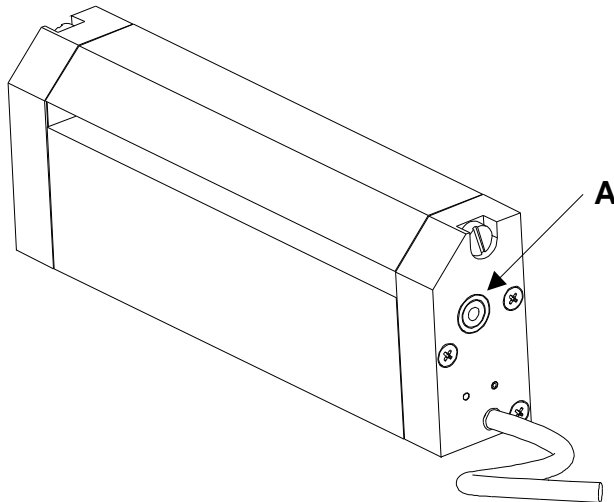

1. There are two adjustable opening showed as arrow “A” on the cutter.
2. The paper jam may cause the cutter work improperly, power off the printer.
3. Use #M3 Hex Key insert into the opening “A” and turn clockwise. The blade of cutter should be opened, then remove the paper inside the cutter.
4. After the paper jam problem is eliminated, power on the printer, at this moment, the cutter will regress automatically to cutting position.